

Als fabrikant kan ik u het volgende aanbieden :

Beugels bestaande uit :

- Buis  $\varnothing$  104x2 – rvs 304/316
- Voetflenzen  $\varnothing$  200 – dikte 10 mm en voorzien van 4 gaten  $\varnothing$  18
- Afwerking : geslepen
- Lassen gebeitst
- **Alles gevuld met beton**

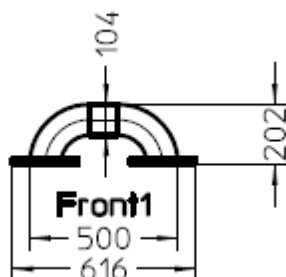

Code		gewicht
BEU-VF-104x2x500 – rvs 304		20 kg
BEU-VF-104x2x500 – rvs 316		20 kg

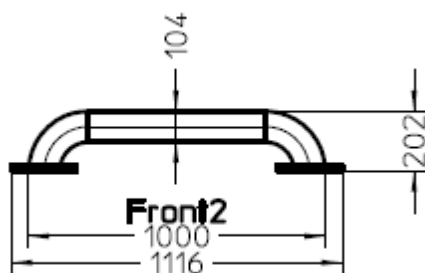

Code		gewicht
BEU-VF-104x2x1000 – rvs 304		32 kg
BEU-VF-104x2x1000 – rvs 316		32 kg

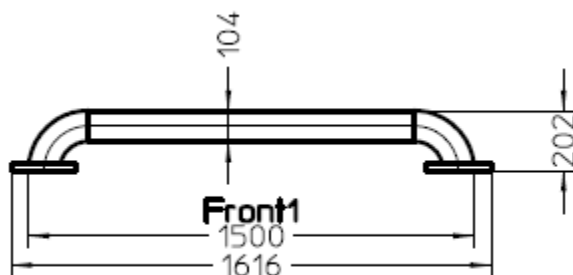

Code		gewicht
BEU-VF-104x2x1500 – rvs 304		45 kg
BEU-VF-104x2x1500 – rvs 316		45 kg

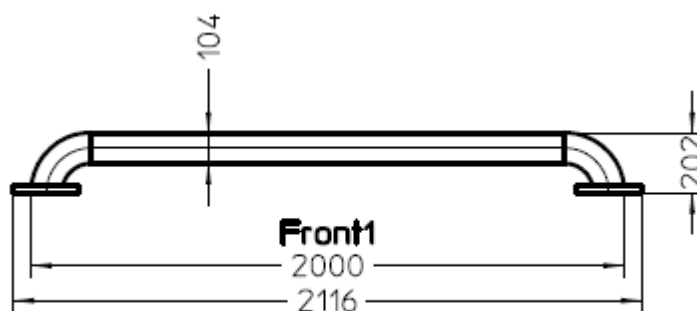

Code		gewicht
BEU-VF-104x2x2000 – rvs 304		57 kg
BEU-VF-104x2x2000 – rvs 316		57 kg

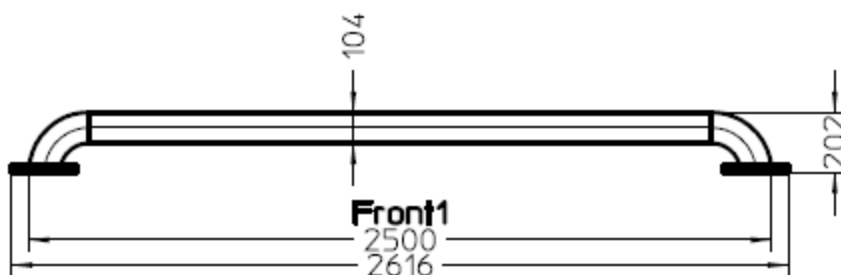

Code		gewicht
BEU-VF-104x2x2500 – rvs 304		70 kg
BEU-VF-104x2x2500 – rvs 316		70 kg

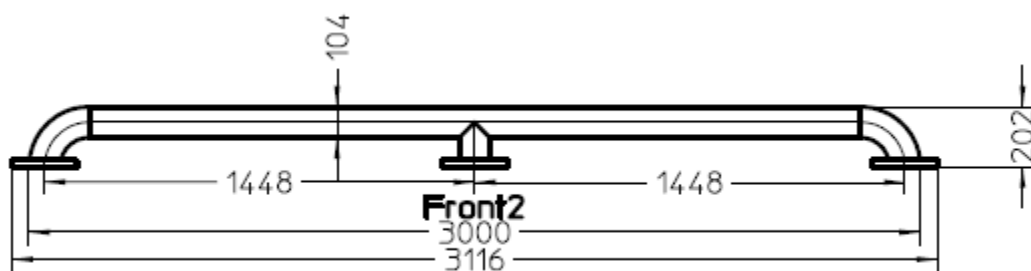

Code	gewicht
BEU-VF-104x2x3000 – rvs 304	86 kg
BEU-VF-104x2x3000 – rvs 316	86 kg

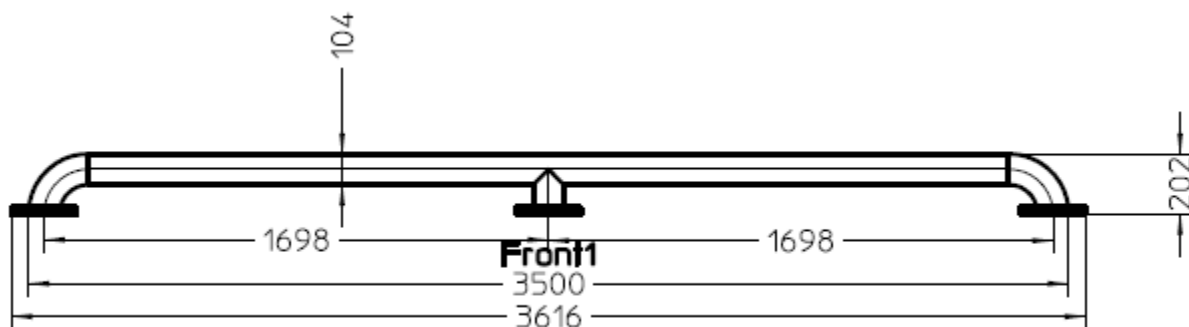

Code	gewicht
BEU-VF-104x2x3500 – rvs 304	99 kg
BEU-VF-104x2x3500 – rvs 316	99 kg

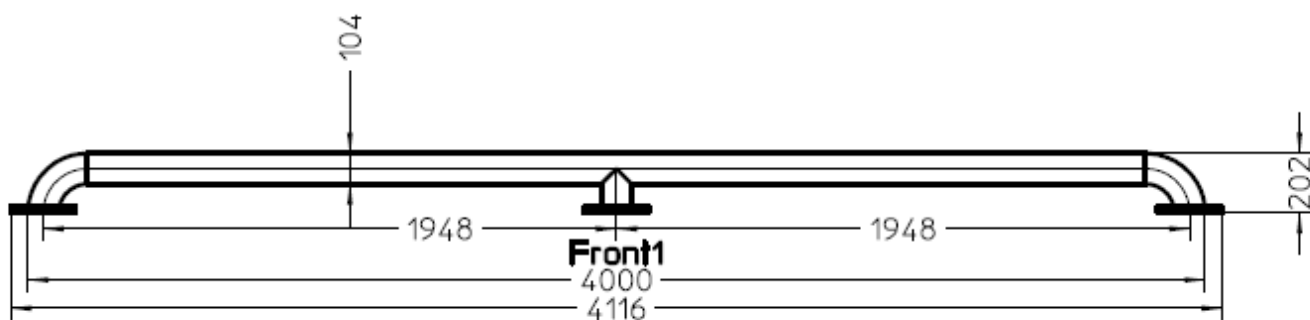

Code	gewicht
BEU-VF-104x2x4000 – rvs 304	112 kg
BEU-VF-104x2x4000 – rvs 316	112 kg

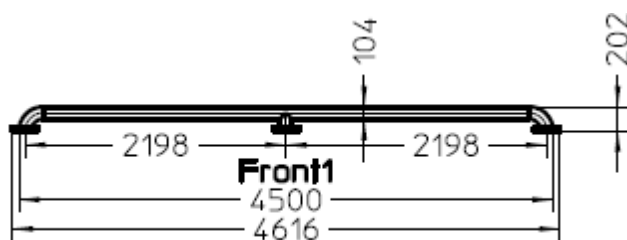

Code	gewicht
BEU-VF-104x2x4500 – rvs 304	124 kg
BEU-VF-104x2x4500 – rvs 316	124 kg

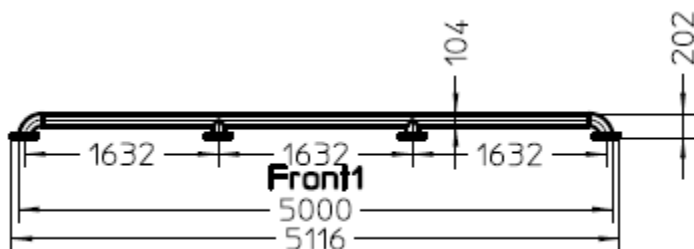

Code	gewicht
BEU-VF-104x2x5000 – rvs 304	141 kg
BEU-VF-104x2x5000 – rvs 316	141 kg

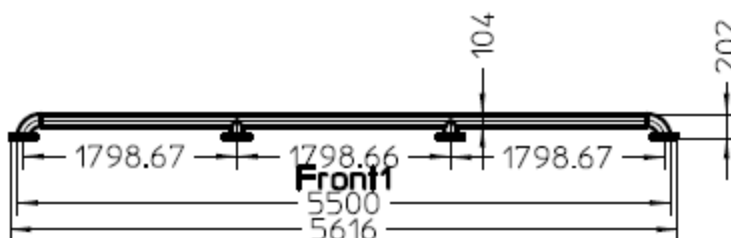

Code	gewicht
BEU-VF-104x2x5500 – rvs 304	153 kg
BEU-VF-104x2x5500 – rvs 316	153 kg

RVS, AISI  
304/316

## Rechte aanrijbeveiliging - voetflens

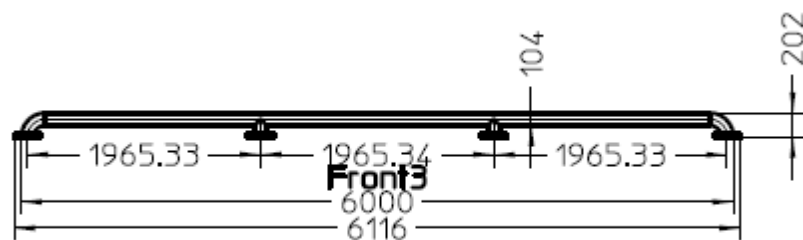

Code		gewicht
BEU-VF-104x2x6000 – rvs 304		166 kg
BEU-VF-104x2x6000 – rvs 316		166 kg